

UFO 13D Downlight

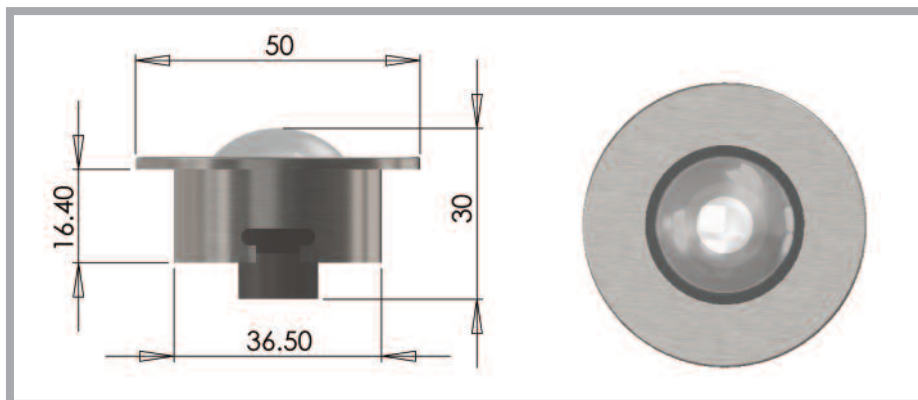

A fixed lens downlight fitting, secured through ceiling with spring clips.

Available in a range of finishes, this fitting allows for the light beam to be focused. The fitting is also suitable for mounting in the base of a display case and illuminating upwards.

Description	
Lens	Clear focusing lens
Material	Aluminium, stainless steel or polycarbonate
Colours available	Polished aluminium, chrome, black, white, ivory
Focus range	20° - 45°
Flange size	Ø50 mm
Weight	44.4g (aluminium) 18.8g (polycarbonate) 106.4g (stainless steel)
Mounting hole size	40 mm
Mounting	Recessed, held by springs
Ferrule size	M10 or 8 mm smooth
Min. fibre size	2 mm
Max. fibre size	8 mm

Our downlight fittings are suitable for use in a variety of different applications and are the ideal solution for the illumination of static objects within a display case or cabinet.

Uses include:

- Museum and gallery cabinet and display lighting
- Accentuation of pictures and other objects
- Illumination of shop displays