

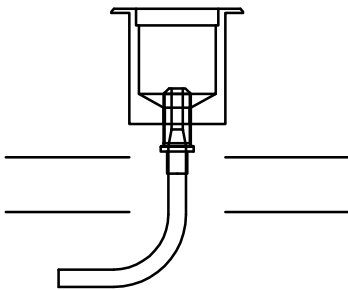

Cutout Required: 72mm

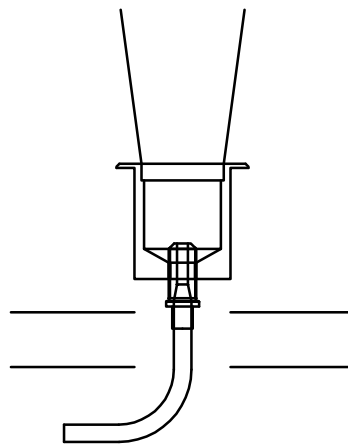

(1) Hold fibre optic tail in hand gently and screw on fitting.



(2) A narrow beam of light is produced if the fitting is screwed on by a few threads.

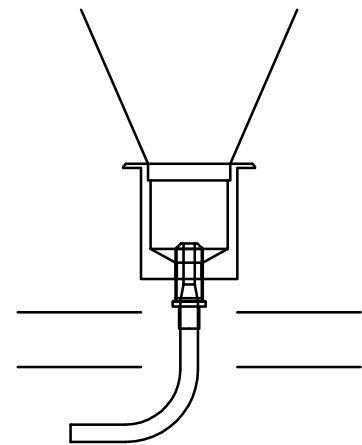

(3) A wider beam of light is produced if the fitting is screwed on almost as far as it will go.

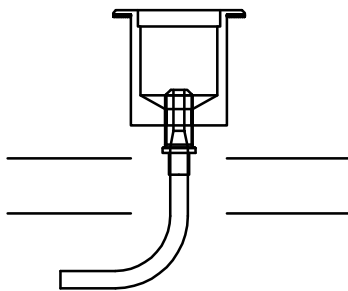

(4) Apply some silicone sealant to the underside of the paver's lip to provide adhesion to the mounting surface.

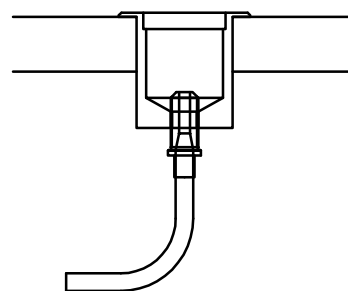

(5) Drop the paver into its hole.