

PRODUCT USER GUIDE

Vega SLP Light Source



Rev: C6



PLEASE READ THIS USER GUIDE BEFORE INSTALLING, OPERATING
OR PERFORMING MAINTENANCE ON THE LIGHT SOURCE UNIT



INTRODUCTION

Thank you for purchasing this UFO light source.

To ensure that the light source is set up optimally and gives a long service life, please read this user guide before installing, operating or performing any maintenance on the unit.

This luminaire is powered by a 24V power supply or a 24V constant voltage driver.

Please keep this user guide for future reference.

This light source is suitable for indoor use only unless it is situated in a weatherproof enclosure.

MODELS COVERED BY THIS USER GUIDE

UFO Vega SLP-2700M / UFO Vega SLP-3000M / UFO Vega SLP-4000M

UFO Vega SLP-2700DMX / UFO Vega SLP-3000DMX / UFO Vega SLP-4000DMX

UFO Vega SLP-270010V / UFO Vega SLP-300010V / UFO Vega SLP-400010V

IMPORTANT

This product must be installed in accordance with the applicable installation code, by a person familiar with the construction and operation of the product, and the hazards involved.

These light sources are not mains dimmable.

The LED array and heatsink in this light source can be replaced when it reaches end of life. Contact UFO for details.

Type Y Attachment: If the external flexible cable or cord of this luminaire or associated PSU/driver is damaged. It shall be exclusively replaced by the manufacturer or his service agent or a similar qualified person to avoid a hazard.

Location: Do not locate this light source closer than 200mm from any flammable surface.

Clearance / Ventilation: It is imperative that a gap of 200mm is left around the unit. This is to allow air to circulate and prevent overheating. The location must have free ventilation and must not have an ambient temperature higher than that specified for the luminaire.

Mounting: This is a fixed luminaire. See mounting plate instruction on Page 3 for fixing to surface.

Warning: Never look directly into the luminaire LED light source.

Warning: The luminaire should be positioned so that prolonged staring into the luminaire at a distance closer than 0.33m is not expected.

UFO will accept no liability for damage, or associated claims, caused by not following the installation and safety instructions contained within this user guide.

ATTACH THE LIGHT SOURCE TO ITS MOUNTING PLATE

Fit the metal mounting plate to the base of the light source before making electrical connections.

Remove the mounting plate and the four plastic 2 part (screw and rivet body) from the box. Invert the light source and remove the four rubber feet. Separate the screws from the rivet bodies and push fit the rivet bodies into the holes vacated by the feet.

Align the plate against the rivets and secure the plate to the light source with the four plastic screws using an M4 pozi-drive screwdriver. Do not overtighten. The light source can now be fixed securely to the mounting surface.

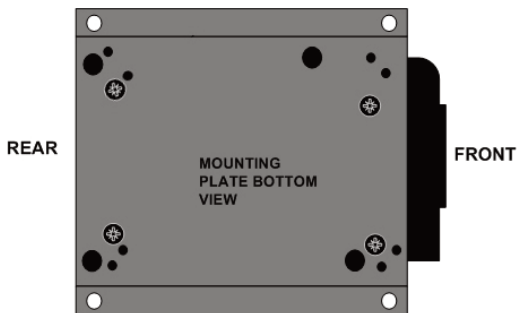
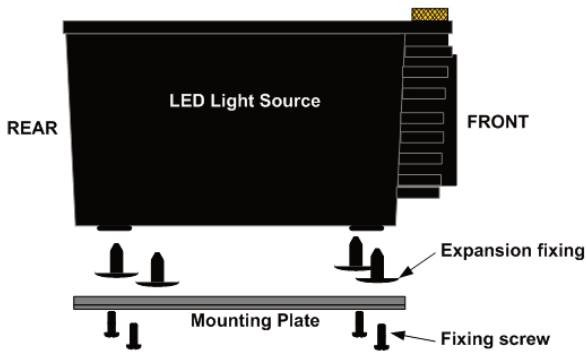

Note: Mounting plate diagram is indicative only.

POWER SUPPLY REQUIREMENTS

The light source is powered from a 24V DC PSU or a Constant Voltage SELV LED driver.

The driver caters for UK/European/other mains supplies using the relevant power cord supplied.



VEGA SLP-XXXXM CONNECTIONS



VEGA SLP-XXXXDMX / 10V CONNECTIONS

CONNECTION - VEGA M MODELS ONLY

There are 2 connections required – the fibre port and the mains supply cable. The fibre port should be connected first. Connect and secure the fibre optic connector into the collar and secure using the M5 locking screw.

Connect the PSU to the DC input jack socket on the light source, and connect the IEC cable to the PSU. Plug the mains plug into the electrical supply socket. Switch on power. The led indicator will illuminate and the light source is ready for use. If no light is produced consult the TROUBLESHOOTING section of this user guide.

Note: these light sources are not mains dimmable.

CONNECTION - VEGA DMX MODELS ONLY

There are 3 connections required – the fibre port, the mains supply cable and the DMX control cable(s). The fibre port should be connected first. Connect and secure the fibre optic connector into the collar and secure using the M5 locking screw.

Connect the PSU to the DC input jack socket on the light source, and connect the IEC plug to the PSU. Plug the mains plug into the electrical supply socket. Switch on power – the red LED Indicator will illuminate and the light source is ready for use. If no light is produced consult the TROUBLESHOOTING section of this user guide.

Connect the DMX control cable(s) to the Mini-XLR socket(s) on the rear of the light source. The recommended plugs for these sockets are Multicomp SVP556-TA (female) or Multicomp SVP555-TA (male). The pin out details for the plugs are shown below. Either socket may be used as DMX in or DMX out.

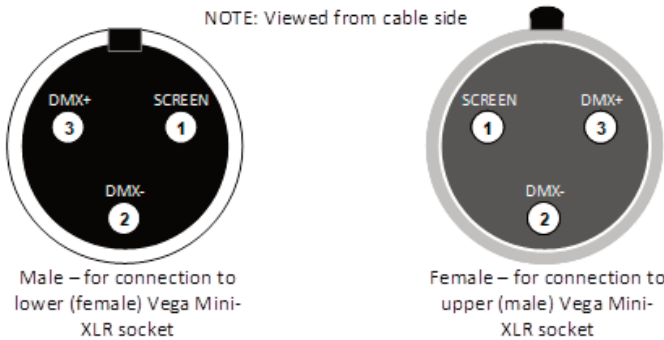

Note: UFO can supply converters for these light sources to allow them to be interfaced to standard 3 pin XLR connectors or RJ45 connectors.

CONNECTION - VEGA 0-10V MODELS ONLY

This is external current source dimming - the light source dimming input requires an external 0-10V source.

There are three connections required - the fibre port, the mains supply cable and the 0-10V control cable. The fibre port should be connected first. Connect and secure the fibre optic connector into the collar and secure using the M5 locking screw.

Connect the PSU to the DC input jack socket on the light source, and connect the IEC cable to the PSU. Plug the mains plug into the electrical supply socket. Switch on power – the red LED indicator will illuminate and the light source is ready for use. If no light is produced, consult the TROUBLESHOOTING section of this user guide.

THE LIGHT SOURCE WILL NOT ILLUMINATE UNLESS DIP SWITCH 10 IS ON AND A 0-10V SIGNAL IS PRESENT.

Connect the 0-10V control cable(s) to the Mini-XLR socket(s) on the rear of the light source. The recommended plugs for these sockets are Multicomp SVP556-TA (female) or Multicomp SVP555-TA (male). The pin out details for these plugs are shown below. Either socket may be used as 0-10V IN or 0-10V OUT

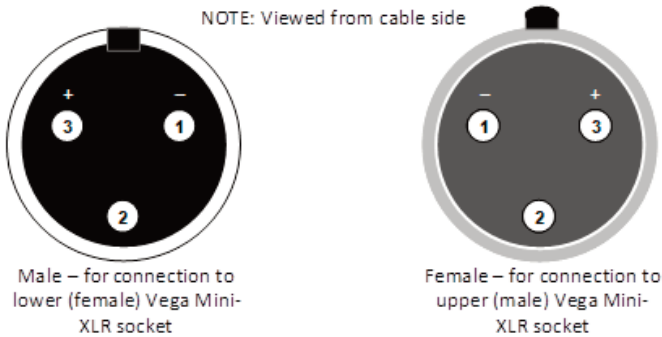

Note: UFO can supply converters for these light sources to allow them to be interfaced to standard 3 pin XLR connectors or RJ45 connectors.

OPERATION

USING THE LIGHT SOURCE - VEGA M MODELS ONLY

Under normal operation the VEGA M light source can be dimmed manually using the dimmer control on the rear of the unit.

USING THE LIGHT SOURCE - VEGA DMX MODELS ONLY

The DMX light sources can be dimmed remotely (single channel 0-255 – see table below) and can be addressed manually.

Single Channel Value	0	255
Description	LED off	LED brightest

Unless the address is specified on the purchase order, all light sources will be defaulted to address 001. Connect the DMX controller to either of the Mini XLR sockets, and the light source can now be dimmed. Additional slave (which are set to the same address) DMX light sources can be linked together.

REVERTING A DMX LIGHT SOURCE TO MANUAL OPERATION MODE

1. Disconnect the light source from the mains supply.
2. Tilt the light source on its side and remove the screw from the base as shown below.
3. Slide the access cover down to remove and set the cover and screw aside.
4. Switch DIP switch 10 (top) to ON as shown below.
5. Replace access cover and securing screw.

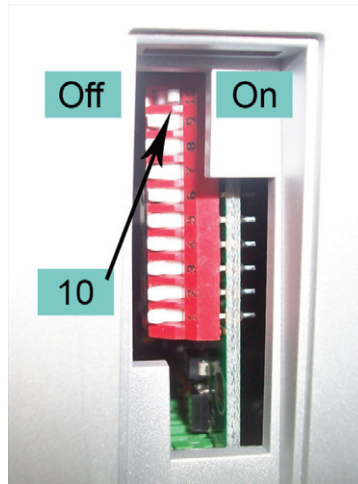

SETTING THE DMX ADDRESS

1. Disconnect the light source from the mains supply.
2. Tilt the light source on its side and remove the screw from the base as shown below.
3. Slide the access cover down to remove and set the cover and screw aside.
4. Ensure DIP switch 10 (top) is set to OFF as shown below.
5. Set the address required as detailed in the address table, overleaf.
6. Replace access cover and securing screw,

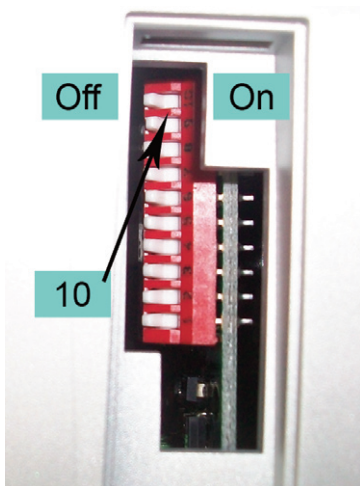

Note: for DMX control operation to work, dip switch 10 must be in the off position.

See the table and diagram on the following page for instructions on setting the DMX address using dip switches.

OPERATION

SETTING THE DMX ADDRESS

DMX B Start Channel #	Dip Switches On	DMX B Start Channel #	Dip Switches On
1	1	11	1,2,4
2	2	12	3,4
3	1,2	13	1,3,4
4	3	14	2,3,4
5	1,3	15	1,2,3,4
6	2,3	16	5
7	1,2,3	:	:
8	4	:	:
9	1,4	:	;
10	2,4	511	1,2,3,4,5,6,7,8,9

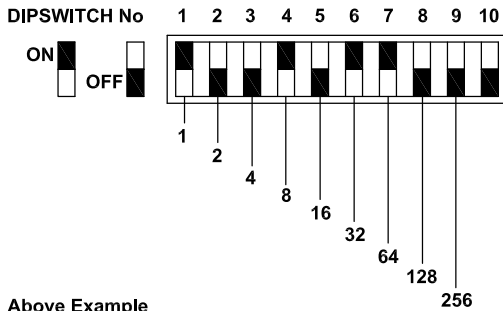

Above Example

1 - ON 6 - ON
 2 - OFF 7 - ON
 3 - OFF 8 - OFF = ADDRESS 105
 4 - ON 9 - OFF
 5 - OFF 10 - OFF

Note: with dip switch 10 OFF, the light source will not illuminate unless a DMX signal is present.

USING THE LIGHT SOURCE - VEGA 0-10V MODELS ONLY

Vega 0-10V models allow the light output to be varied by applying a different voltage through the rear connectors. The following table represents light output percentage against approximate control value input.

Light Output Percentage	Voltage
100%	7 - 10V
90%	6.2V
80%	5.8V
70%	5.4V
60%	5V
50%	4.5V
40%	3.9V
30%	3.2V
20%	2.3V
10%	1.4V
5%	1.1V
2.5%	0.8V
1.25%	0.4V
0%	0.2V

Note: the light source will not illuminate unless dip switch 10 is on and a 0-10V control voltage is in place.

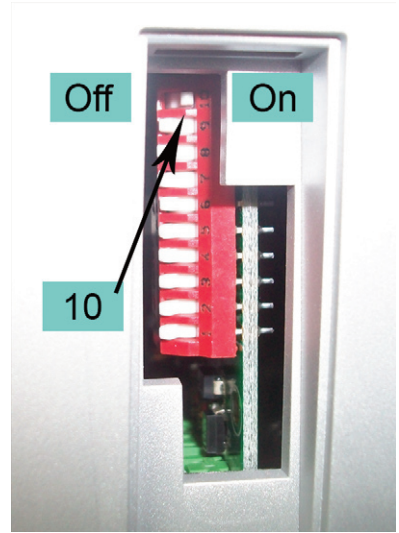

MAINTENANCE

To ensure a long working life and the safe, reliable operation of the light source, it is very important to maintain it properly and ensure it is installed in an appropriate and safe location.

Before performing any maintenance on the light source it should be disconnected from the power supply and allowed to cool down.

- The light source fans and vents should be blown out with compressed air at least every 12 months, or more often if located in a dusty environment.
- Do not allow dust to build up on internal pcb's & components as this will increase heat within the light source and lead to failure. Units should be checked regularly and all dust must be vacuumed off. Failure caused by excessive dust will not be covered under warranty.
- After the light source has been installed, check the fans and vents to ensure they are clear of dust and debris. Blow out with compressed air if required.
- The body of the light source can be cleaned using a soft damp cloth. Do not use any abrasives on the unit.

Note that a record of all maintenance **MUST** be kept in the table below, indicating what maintenance was undertaken. This must be dated and is required for warranty purposes.

SAFETY GUIDANCE

- A gap of 200mm (8") **MUST** be left around the unit. This is to allow air to circulate and prevent overheating. The location must have free ventilation and must not have an ambient temperature higher than that specified for the luminaire.
- The outer body of the light source may become hot - keep away from all combustible materials and **DO NOT** locate this light source within 200mm (8") of any flammable surface.
- The light source must not be run without the fibre optic harness fitted.

MAINTENANCE LOG

Date	Maintenance Undertaken

PROCEDURES FOR ALL MODEL TYPES

Problem	Possible Cause(s)	Remedy
Unit is dead – no light output and LED power indicator on PSU is not illuminated	Mains supply off	Check supply & reinstate
	Loose mains plugs	Check plugs
	Plug fuse blown (UK)	Check fuse. If blown, replace
	PSU failed	Replace PSU
Unit is dead – no light output and LED power indicator on PSU is illuminated, but LED indicator on Light source not illuminated	PSU failed	Replace PSU
Unit is dead – no light output but LED power indicator is illuminated	DMX dimming at minimum (for DMX version only)	Adjust brightness on controller (increase value up from 0)
	DMX fault on controller or DMX cable	Remove DMX XLR plug from rear of light source. Light source will default to full bright. Repair DMX controller or cabling.
	LED array failure	Contact UFO
Unit not responding to DMX commands	Address incorrect	Check the address set on unit matches the address set on the controller
	DMX cable fault	Refer to manual diagram for correct wiring termination. Carry out continuity check.
		Swap DMX cable for known good cable

Note: please complete relevant troubleshooting procedures before returning the unit to us for further investigation.

ADDITIONAL PROCEDURES FOR 0-10V MODELS ONLY

Problem	Possible Cause(s)	Remedy
0-10V Version unit is dead - no light output - but LED indicator on light source is illuminated.	No 0-10V dimming to unit (0V= LED Off)	Refer to manual diagram for correct termination. Carry out continuity check. Carry out voltage / polarity 0-10V cable fault check
	0-10V cable fault	
	Controller fault	Carry out voltage / polarity check at controller. Repair / replace as necessary
	0-10V LED PCB failure	Replace 0-10V PCB
No 0-10V signal present	Controller off or failed	Check controller. Ensure 0-10V signal present
	0-10V cable faulty	Carry out voltage and polarity check on mini XLR plug. Repair as necessary

Note: please complete relevant troubleshooting procedures before returning the unit to us for further investigation.

Description	Details
Port connector size	30mm diameter
Fibre type	Glass / PMMA
Mains Supply Voltage	100-240V AC, 50-60Hz, 1.8A
PSU Output	24V DC, 2.5A, 60W max.
LED Power	20W
Min Ambient Temperature	-10°C
Max Ambient Temperature	+45°C
Fan	60mm crossflow, 12V
Led Type	White light
DMX [specific models only]	User addressable 1 channel dimming
0-10V [specific models only]	0-10V DC receiving
LED Life	50,000 hours typical
CRI	>82 (typical)
Colour Temperature	2700°K, 3000°K or 4000°K
Material	ABS
Finish	Grey
Dimensions (L x W x H) / Weight	222mm x 114mm x 81mm / 920g



United Kingdom • United States • Germany • Europe • UAE

Universal Fibre Optics Ltd
Home Place \ Coldstream
TD12 4DT \ UK
+44 (0)1890 883416
www.ufo.lighting

Universal Fiber Optics USA LLC
1749 Northgate Blvd
Sarasota \ FL34234 \ USA
941-343-8115
www.fiberopticalighting.com

UFO Licht GmbH
Andreasstraße 20
93059 Regensburg \ Deutschland
+49 (0)9491 955880
www.ufo-licht.de